

Lifeloc
Professional Breath Alcohol Tester

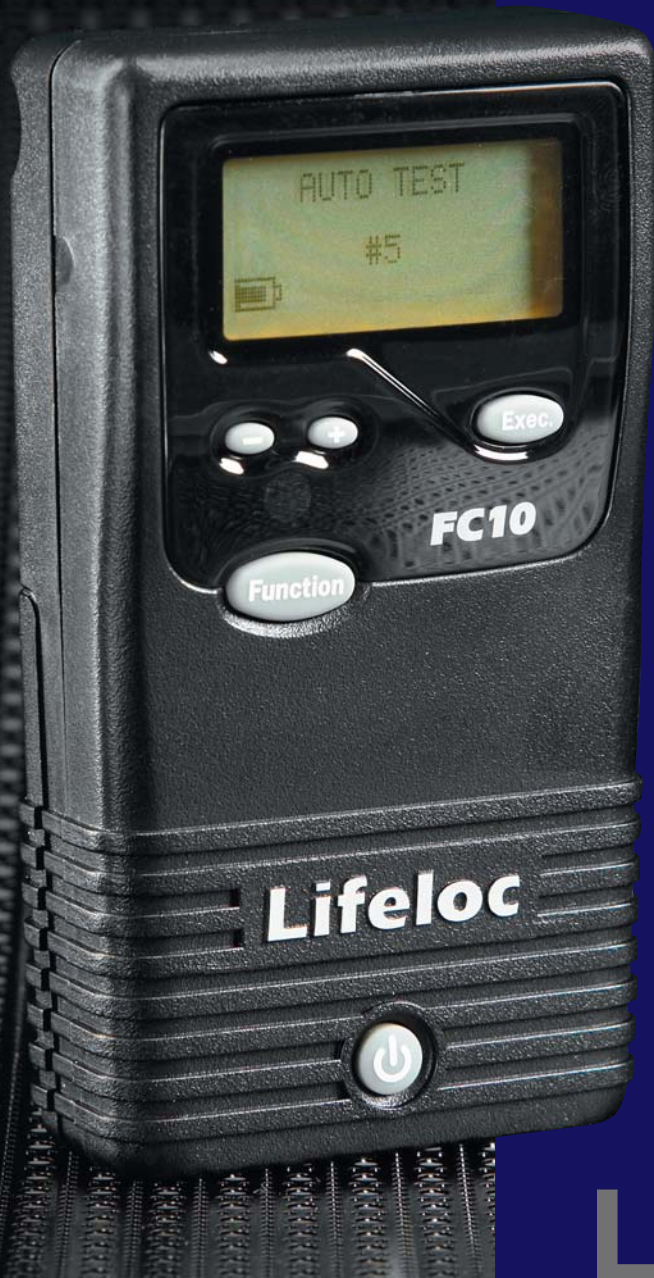

Lifeloc FC10

Operations Manual

Unlock the Power
of Alcohol Testing

Table of Contents

Introduction

Congratulations	4
Front View	5
Features.....	6

Preparation

Installing Batteries.....	7
Turning the FC On and Off.....	7
Observing the Subject.....	8
Attaching a Mouthpiece	8

Breath Testing Modes

Testing Modes Explained	9
End of Breath & Precise Volume Explained.....	9
Conducting an Automatic Test.....	10
Manual Override During an Automatic Test	10
Conducting a Manual Test	11
Conducting a Passive Test.....	11

Operation

Breath Flow.....	12
Alcohol Curve.....	12
Test Results	12
Viewing Previous Test Results	12
Removing the Mouthpiece	12

User Settings

Setting the Default Test Order.....	13
Setting the Trigger Mode.....	13

Calibration Settings

Calibration/Cal Check Explained	14
Wet Bath and Dry Gas Explained.....	14 - 15
Selecting the Calibration Standard.....	15
Selecting the Standard Type	16

Table of Contents

Wet Bath Calibration

Wet Bath Simulator Set-Up	16
Wet Calibration.....	17
Wet Calibration Check.....	18

Dry Gas Calibration

Dry Gas Tank Set-Up.....	19
Dry Gas Calibration	19-20
Dry Gas Calibration Check.....	20-21

Maintenance

Fuel Cells.....	21
Cleaning.....	21
Batteries	21

On-Screen Messages

Messages Explained.....	22
-------------------------	----

Service

Lifeloc Factory Warranty	23
Extended Service Plans.....	23
Service.....	23

General Usage

Notice	24
Specifications	24

FC10 Supplies

Accessories and Supplies	25
--------------------------------	----

Menu Charts

User Settings Chart.....	26
Calibration Display Chart.....	26

Attention FC10 Operator:

Congratulations on your purchase of a Lifeloc FC10.

For over 25 years, Lifeloc Technologies has been providing advanced alcohol testing equipment & training to Law Enforcement and Corrections Professionals. We are the leader in product innovation, precision instruments, ease of use & Five Star Customer Care.

The FC10 breath alcohol tester is manufactured in Wheat Ridge, Colorado, by Lifeloc Technologies, Inc. Lifeloc offers premium quality products combined with exceptional service and technical support.

The FC10 is a state-of-the-art breath alcohol tester that is software based and incorporates unique cutting edge technologies. Because of the advanced FC10 design:

- Results on a positive test register within 10 seconds.
- You can take another test within 30 seconds after a positive. Repeatability is not compromised.
- Your FC10 will automatically take the test when it senses a deep lung sample is delivered.
- Your FC10 will provide an accurate test, or else explain to you why it cannot, and even provide suggestions on how to proceed to complete an accurate test on your subject.
- AA or NiMH batteries last for about 160 “on” hours or up to 6000 tests.

The following pages will explain in detail the operation of your FC Series portable breath tester.

Unlock the Power of Alcohol Testing

Front View (with Mouthpiece)

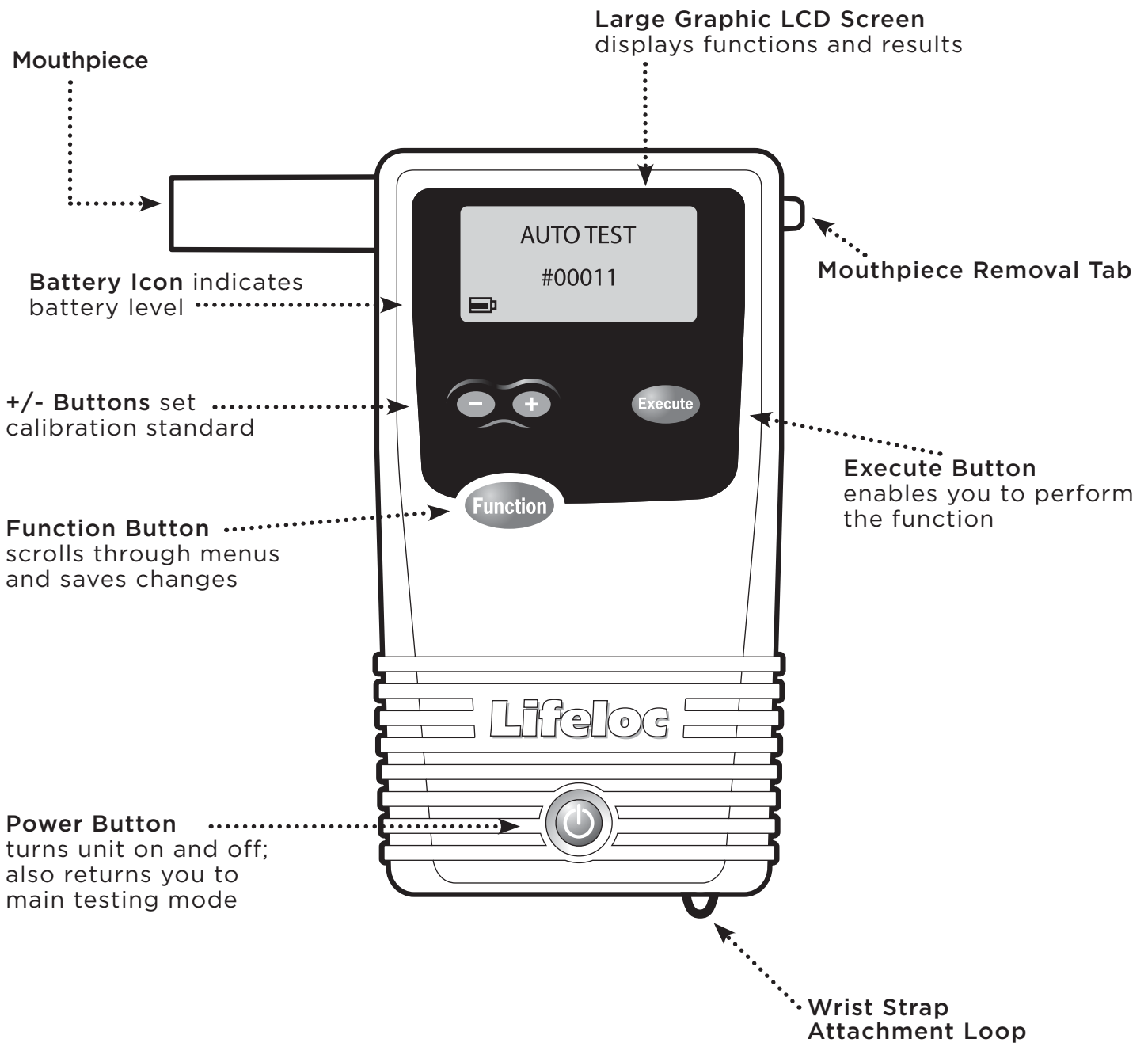

Features

- **Large Graphic LCD Display:** Capable of showing numbers, letters, icons and plain English text messages.
- **Automated Calibration:** Software-controlled adjustments; no tools necessary.
- **Auto Test Mode:** The easiest way to take a test. Tester automatically takes deep lung sample when subject is at end of breath.
- **Manual Test Mode:** Enables operator to control exact point of breath sample.
- **Passive Test Mode:** Checks for the presence of alcohol in the breath or in an open container, without using a mouthpiece.
- **User-Selectable Test Order:** Allows choice of either Auto Test or Passive Test default mode.
- **Auto Shut-Off:** Preserves battery life.
- **Fast, Simple Operation:** While the FC10 contains a host of features, it is still very easy to use.
- **Automatic Backlight:** Easy viewing of test results either day or night.
- **Exceptional Battery Life:** Up to 160 hours or 6000 test operation using four AA or NiMH rechargeable batteries.

Installing Batteries

Press in and down on the battery door located on the back of the FC10.

Install the four AA Alkaline batteries in the direction of the symbols in the battery case.

Close the case by pushing up on the battery door until it locks shut.

See page 21 for directions on using rechargeable batteries.

Turning the FC On and Off

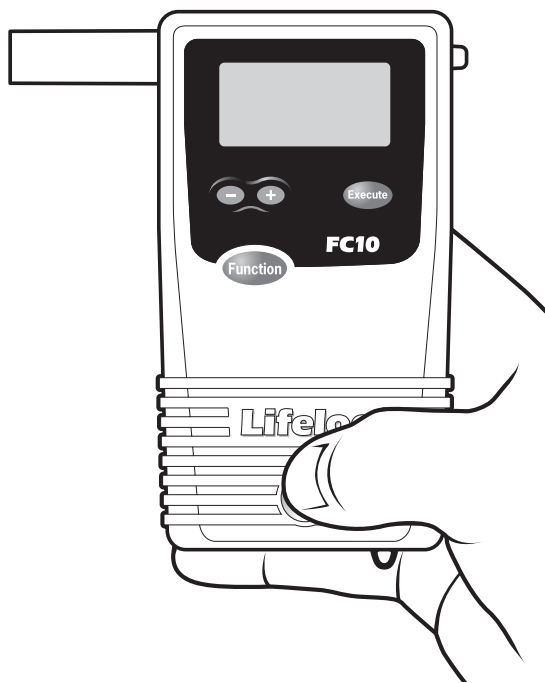

Press and hold the Power button on the bottom of the front of the unit until it beeps. The FC10 performs an automatic internal diagnostics check.

To turn the unit off, press and hold the **Power** button until it beeps twice. The unit will shut down.

Note: Momentarily pressing the Power button, when the unit is on, will return you to the main menu.

Observing the Subject

The FC10 provides a highly accurate reading of breath alcohol acquired by sampling deep lung air. Readings will also detect residual mouth alcohol.

To prevent mouth alcohol from affecting a test, make certain that the subject is not allowed to put anything in their mouth for 15 minutes prior to taking a test.

If the subject just took a drink, a 15 minute observation period in which they are not permitted to put anything in their mouth should be observed before testing. This will ensure all residual alcohol from any source has completely dissipated and test results will be valid.

Attaching a Mouthpiece

Remove the mouthpiece from its wrapper, making sure not to touch the end which the subject will be blowing into.

Attach the mouthpiece to the port on the back of the FC10.

Line up the mouthpiece port over the holes in the back of the mouthpiece. Press in place.

Ensure it is securely attached.

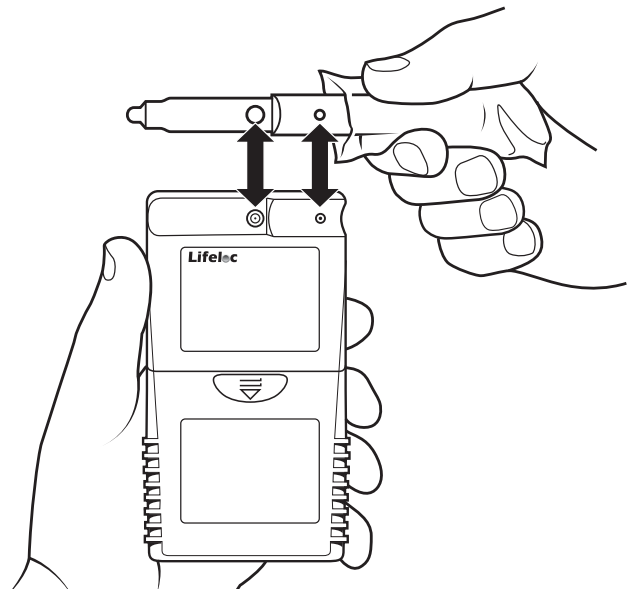

Breath Testing Modes Explained

The FC10 is capable of conducting Automatic, Manual, and Passive tests.

- **Automatic Test** is the easiest way to achieve a deep lung sample. The FC10 monitors the subject's breath and automatically takes the sample near the end of the breath flow.
- **Manual Test** is normally used only when the subject is unable to provide a sufficient breath sample for the automatic test.
- **Passive Test** is a quick screen to detect alcohol but is not designed to quantify the results. Passive results are reported as "POS" if alcohol is detected, "NEG" if alcohol is not detected. In this mode, no mouthpiece is required.

End of Breath and Precise Volume Explained

In Auto Test mode, the unit can be set to take a sample either:

- When the subject nears the end of the exhalation (**End of Breath**)
- or —
- When it detects 1.5L of breath (**Precise Volume**)

Both will give accurate results. Precise Volume may work better with uncooperative subjects.

(To select "END OF BREATH" or "PRECISE VOLUME" mode, see Trigger Mode instructions on p.13)

Conducting an Automatic Test

Turn the FC10 on.

Verify the display reads “AUTO TEST.”

Attach the mouthpiece to the back of the unit.

Instruct subject to blow into the mouthpiece **firmly and steadily for as long as they can**. (But not necessarily as hard as they can.) The unit calculates volume and will give an error message if the subject cannot reach 1.3 liters.

Read the result.

After taking a test, the FC10 will display the results in large numbers on the display.

Press the **Function** button to return to the test mode.

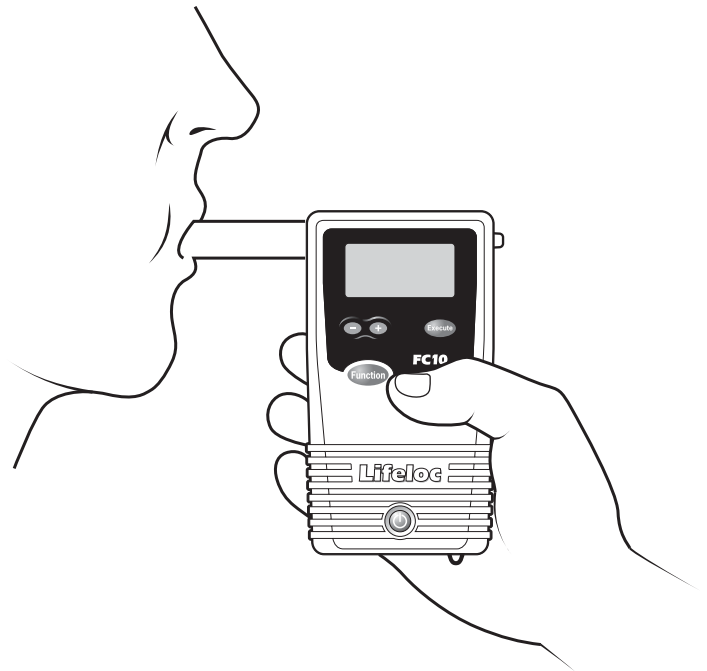

Manual Override during an Automatic Test

Note: This feature allows the completion of a test in the occasional instance when the subject may have diminished lung capacity and cannot activate the Auto Test.

Turn the FC10 on.

Attach a mouthpiece to the back of the unit and verify the display reads “AUTO TEST”.

Instruct the subject to blow into the mouthpiece **firmly and steadily for as long as they can**.

When they are near the end of their breath, press the **Execute** button.

Read the result.

Conducting a Manual Test

Turn the FC10 on.

Attach the mouthpiece to the back of the unit.

Press the **Function** button until the display reads "MANUAL TEST".

Instruct the subject to blow into the mouthpiece **firmly and steadily for as long as they can**.

When they are near the end of their breath, press the **Execute** button.

Read the result.

Please note: manual test mode is pressure activated. If the subject does not blow air into the mouthpiece, the test can not be conducted.

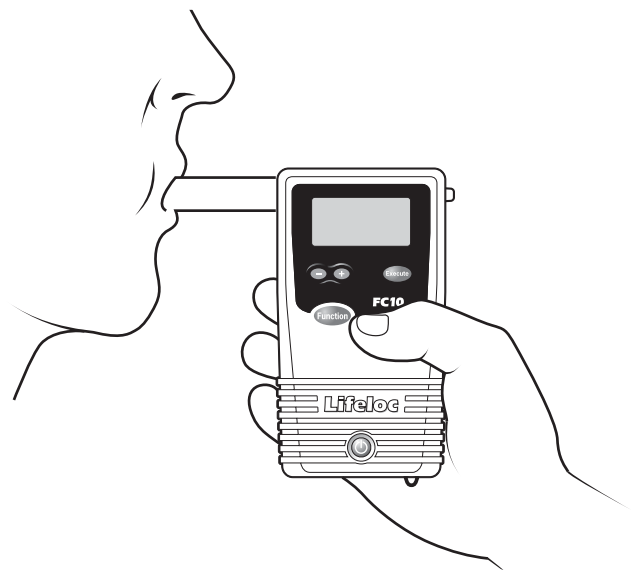

Conducting a Passive Test (No Mouthpiece)

Turn the FC10 on.

Press the **Function** button, if necessary, until the display reads "PASSIVE TEST."

Hold the FC10 sample port (orange-colored opening labeled "Port" on the back of the FC10) about 4 inches from the subject's mouth.

Have the subject blow toward the port.

Press the **Execute** button while the subject is blowing.

Read the result. The unit will only display "POS" or "NEG." It will not display the actual numerical result.

Note: A passive test can also be done over an open container to detect the presence of alcohol.

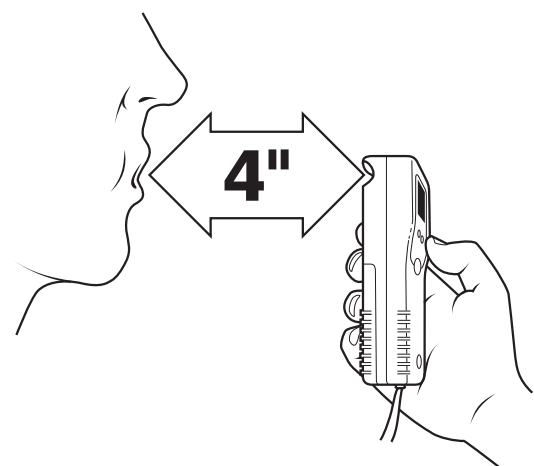

Breath Flow

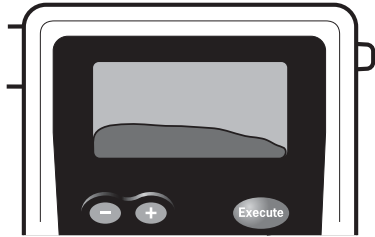

As the subject blows into the mouthpiece, the FC10 will show a graph of the breath flow on the display, as well as showing the amount of liters. Liters are shown in the upper left corner.

Alcohol Curve

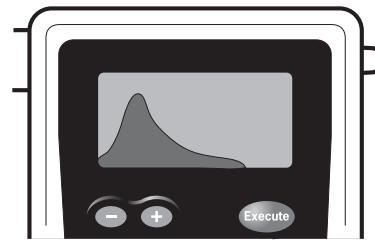

If the FC10 detects alcohol, the alcohol level is graphed and will be displayed before the result.

Test Results

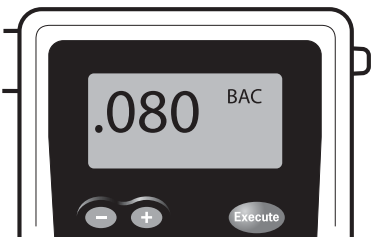

After the alcohol is graphed, the test result is displayed.

The result will remain on the screen until the **Function** or **Power** button is pressed.

The last test result is retained in memory until the next test is administered.

Viewing Previous Test Results

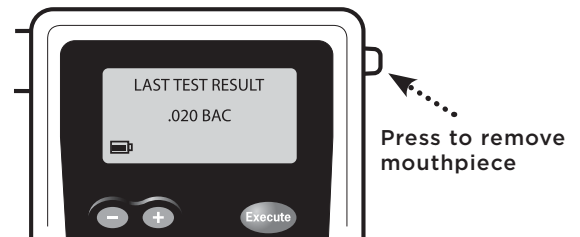

Press the **Function** button until "LAST TEST RESULT" is displayed. The results of the last test will be displayed.

Momentarily press the **Power** button to return to the testing mode.

Removing the Mouthpiece

Remove the mouthpiece by pushing straight down on the tab at the right of the display screen. DO NOT BEND the tab.

Setting the Default Test Order

Test Order 1 (Default)	Test Order 2	Test Order 3
Auto Test Manual Test Passive Test	Passive Test Auto Test Manual Test	Auto Test Manual Test

Press the **Function** button until the display reads “SETTINGS”.

Press the **Execute** button. Display reads “TIME”.

Press the **Function** button until the display reads “DISPLAY SETTINGS”.

Press the **Execute** button. Display reads “LCD CONTRAST”.

Press the **Function** button. Display reads “TEST ORDER”.

Press the **Execute** button to toggle between Test Order 1, 2, and 3 above.

Press the **Function** button to save the changes.

Momentarily press **Power** to return to the testing mode.

Please note: By selecting Test Order 3 you will disable passive testing.

(User settings flow chart is shown on p. 26)

Setting Trigger Mode

From the “SETTINGS” display, press the **Execute** button.

Press the **Function** button until the display reads “TRIGGER MODE.”

Press the **Execute** button to select between “END OF BREATH” and “PRECISE VOLUME.”

Press the **Function** button to save the setting. Momentarily press **Power** to return to the testing mode.

(User settings flow chart is shown on p. 26)

Calibration/Cal Check Explained

Calibration of an FC sets your unit to a known alcohol concentration to enable accurate BAC (Breath Alcohol Concentration) results.

You can use dry gas or wet bath solution to calibrate your FC10. Most commonly used solutions are .100, .080 or .040 BAC.

The FC10 must be between 68° and 95° F (20° - 35° C) to calibrate.

Lifeloc recommends you calibrate your FC:

- Once** every 12 months, regardless of how many tests you have performed
- Or**, at intervals specified by your Internal Policies, Quality Assurance Plan, or State Regulations
- Or**, after two failed Calibration Checks.

A Calibration Check simply verifies the FC was calibrated correctly and is within the acceptable accuracy range. *Calibration check is also referred to as “External Calibration Check,” “Accuracy Check,” “Verification” and “Cal Check.”*

Lifeloc recommends you perform a calibration check on your FC:

- Once** every 30 days
- Or**, at intervals specified by your Internal Policies, Quality Assurance Plan, or State Regulations.

Wet Bath and Dry Gas Explained

You can calibrate and check your FC10 using either the wet bath or dry gas method. You must first set your FC10 to recognize which method or which ‘Standard Type’ you will be using.

Once you choose the Standard Type, the FC10 will store that information in memory and you do not have to set it again unless you change to a different method of performing a calibration/calibration check.

Dry Gas Calibration requires that, prior to calibration, you enter the corrected Standard Value based on your altitude or elevation. Using the chart on the outside of the canister, multiply the number next to your elevation by the standard.

Example:

- Denver, Colorado’s elevation is 5200 ft. above sea level and dry gas standard = .100 BAC.
- Correction factor from tank is .820
- Corrected Standard = $.100 \times .820 = .082$

If you move to a significantly different altitude before calibrating, you will have to change the standard in the FC10.

Wet Bath Calibration does not require altitude correction.

Note: The FC10 comes from the factory set for Wet Bath type and .100 BAC Calibration Standard.

Selecting the Calibration Standard

Press the **Function** button until display reads “CALIBRATION”.

Press the **Execute** button. The display reads either “WET CHECK” or ” DRY CHECK”.

Press the **Function** button until display reads “CAL SETTINGS”.

Press the **Execute** button. The display reads “CAL STANDARD”.

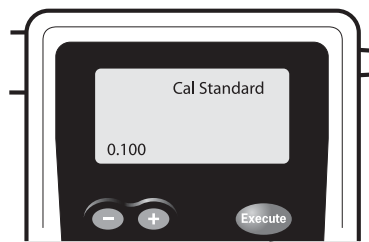

Use the **+ or -** button to change the number to the BAC level of standard you will be calibrating to. It should be the same as on the bottle of certified solution or as your altitude corrected standard, if using a dry gas tank. (See p. 14)

Press the **Function** button to save the settings. Momentarily press **Power** to return to the testing mode.

Once you set the standard, you do not have to set it again unless you change solutions or elevation (dry gas only).

Selecting the Standard Type

Press the **Function** button until display reads “CALIBRATION”.

Press the **Execute** button. The display reads either “WET CHECK” or “DRY CHECK”.

Press the **Function** button until display reads “CAL SETTINGS”.

Press the **Execute** button. The display reads “CAL STANDARD”.

Press the **Function** button until display reads “STANDARD TYPE”.

Press the **Execute** button to choose between “DRY GAS” and “WET BATH”.

Press the **Function** button to save settings. Momentarily press **Power** to return to the testing mode.

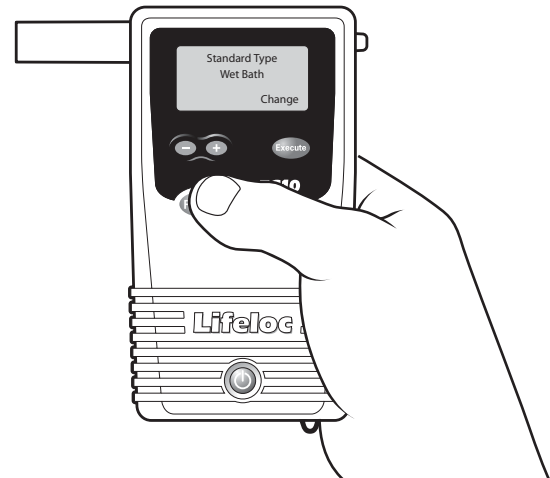

Wet Bath Simulator Set-Up For Calibration & Calibration Check

Pour a bottle of certified alcohol solution into the simulator jar and hand tighten lid.

Connect long tube from input port to output port so no alcohol escapes while simulator heats up.

Plug in the simulator and turn it on.

The simulator automatically heats the solution to 34° C (93.2° F) in about 5 to 10 minutes.

Proper operating temperature is important for accuracy so be certain to check temperature before proceeding.

Performing a Wet Bath Calibration

Prepare the wet bath simulator according to its instructions on page 16.

Disconnect long tube from the output port. Attach a mouthpiece adapter securely to the output port on the simulator lid. Refer to your simulator manual for location.

Turn the FC10 on. Attach a mouthpiece to the back of the unit.

Press the **Function** button until display reads "CALIBRATION", then press the **Execute** button. Display reads "WET CHECK".

Press the **Function** button until display reads "WET CALIBRATE".

Verify the "CAL STANDARD" is set to the concentration of certified alcohol solution you will be using when you calibrate. To select new Calibration Standard, see page 16.

Slide the FC10 mouthpiece over the mouthpiece adaptor on the simulator.

Be prepared to blow into the tube for up to 10 seconds.

Start blowing

- Blow through the input tube (or use a calibration pump) to create and maintain 1/2" of bubbles on the surface of the solution.
- Press **Execute** to proceed and start a 3 second countdown.
- Press **Execute** to take a sample.
- Continue blowing for another 3 seconds.

Stop blowing

If successful, the display will read "CAL COMPLETE".

If no alcohol is detected, display reads "INVALID CALIBRATION". Please repeat calibration setup and test, starting with wet bath simulator setup.

Disconnect the FC10 and wait at least two minutes before conducting a Cal Check to verify the accuracy of your calibration.

Note: Following calibration, a Cal Check is required before the unit allows you to conduct any tests.

(Calibration display flow chart is shown on p. 26)

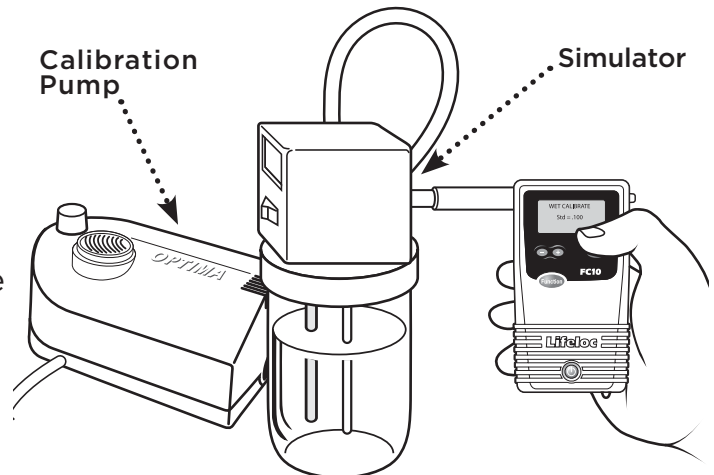

Performing a Wet Calibration Check

Prepare the wet bath simulator according to its instructions on page 16.

Disconnect long tube from the output port. Attach a mouthpiece adapter securely to the output port on the simulator lid. Refer to your simulator manual for location.

Turn the FC10 on. Attach a mouthpiece to the back of the unit.

Press the **Function** button until display reads “CALIBRATION,” then press the **Execute** button. Display reads “WET CHECK”.

Verify the “CAL STANDARD” is set to the concentration of certified alcohol solution you will be using when you check the calibration. To select a new Calibration Standard, see page 16.

Slide the FC10 mouthpiece over the mouthpiece adaptor on the simulator.

Be prepared to blow into the tube for up to 10 seconds.

Start blowing

- Blow through the input tube (or use a calibration pump) to create and maintain 1/2" of bubbles on the surface of the solution.
- Press **Execute** to proceed and start a 3 second countdown.
- Press **Execute** to take a sample.
- Continue blowing for another 3 seconds.

Stop blowing

Read the result. It should be within +/- .005 BAC of the standard used. If your solution is greater than .100 BAC, accurate results will be within +/- 5%.

Example:

- A .100 BAC solution should read between .095 and .105 BAC.
- A .200 BAC solution should read between .190 and .210 BAC.

If no alcohol was detected, the display will read “INVALID CHECK”. Repeat wet bath calibration check instructions.

(Calibration display flow chart is shown on p. 26)

Dry Gas Tank Set-Up

Attach the regulator to the dry gas tank.

Attach the small tube to the output port on the regulator.

Securely fit the mouthpiece adaptor to the small tube on the regulator.

Note: Do not store the dry gas tank with the regulator attached. The regulator is not designed as the primary sealing mechanism. Leaving the regulator attached may result in a leak.

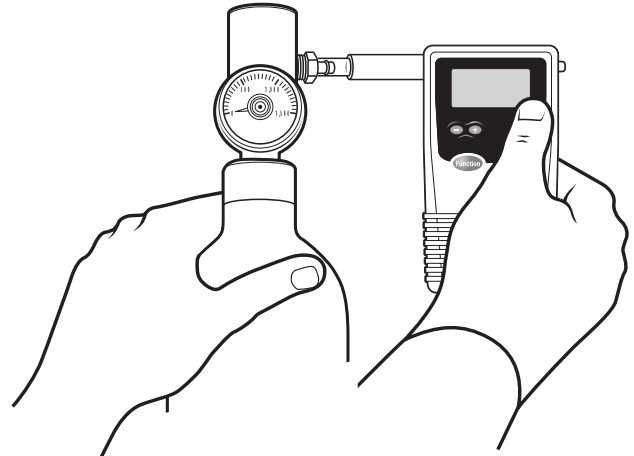

Performing a Dry Gas Calibration

Prepare the dry gas tank according to its instructions above.

Turn FC10 on. Attach a mouthpiece to the back of the unit.

Press the **Function** button until the display reads “CALIBRATION”.

Press the **Execute** button. Display reads “DRY CHECK”.

Press the **Function** button until the display reads “DRY CALIBRATE”.

Verify the Calibration Standard is set to the corrected BAC.

Using the Altitude Correction Factor (ACF) chart on the dry gas tank, calculate the corrected BAC.

$$\text{Corrected Standard} = (\text{tank BAC}) \times (\text{ACF})$$

To select a new Calibration Standard, see page 16.

Attach the FC10 mouthpiece to the regulator by sliding it over the mouthpiece adaptor, ensuring a snug fit.

Be prepared to press the **Gas Tank Regulator** button for up to 10 seconds.

Start pressing (gas flow will start)

- Press the **Execute** button on FC to proceed and start a 3 second countdown.
- Press the **Execute** button again to take a sample.
- Continue holding the **Regulator** button for another 3 seconds.

Stop pressing (gas flow will stop)

If successful, the display will read “CAL COMPLETE”.

If no alcohol is detected, display reads “INVALID CALIBRATION”. Please check gas level on your tank regulator and replace tank if empty. Repeat dry gas calibration instructions on page 19.

Disconnect the equipment and wait at least two minutes before conducting a Cal Check.

Note: Following calibration, a Cal Check is required before the unit allows you to conduct any tests.

(Calibration display flow chart is shown on p. 26)

Performing a Dry Gas Calibration Check

Prepare the dry gas tank according to its instructions on page 19.

Turn FC10 on. Attach a mouthpiece to the back of the unit.

Press the **Function** button until display reads “CALIBRATION”.

Press the **Execute** button. Display reads “DRY CHECK”.

Verify the Calibration Standard is set to the corrected BAC.

Using the Altitude Correction Factor (ACF) chart on the dry gas tank, calculate the corrected BAC.

$$\text{Corrected BAC} = (\text{tank BAC}) \times (\text{ACF})$$

To select a new Calibration Standard, see page 16.

Attach the FC10 mouthpiece to the regulator by sliding it over the mouthpiece adapter, ensuring a snug fit.

Be prepared to press the **Gas Tank Regulator** button for up to 10 seconds.

Start pressing (gas flow will start)

- Press the **Execute** button to proceed and start a 3 second countdown.
- Press the **Execute** button again to take a sample.
- Continue holding the **Regulator** button for another 3 seconds.

Stop pressing (gas flow will stop)

Read the result. It should be within +/- .005 BAC of the corrected standard used. If your solution is greater than .100 BAC, accurate results will be within +/- 5%.

Example: A .082 BAC corrected standard should read between .077 and .087 BAC.

If no alcohol is detected, display reads “INVALID CHECK”. Please check gas level on your tank regulator and replace tank if empty. Repeat dry gas calibration check instructions on page 20.

(Calibration display flow chart is shown on p. 26)

Fuel Cells

Fuel cells are highly durable sensors that are capable of providing accurate breath alcohol results for years. There are, however, a few precautions you should take to make certain that these devices perform for the longest period of time possible.

Use the device. Fuel cells like moisture, so it is a good idea to take tests periodically to provide needed moisture to the fuel cell, especially in dry climates. You do not need alcohol, just breath.

Avoid cigarette smoke! Make certain no one is permitted to blow cigarette smoke into the unit. This can damage or destroy the fuel cell.

Cleaning

Use of a mild disinfectant cleaner and a soft cloth on the outside of the case is recommended periodically to keep your unit clean. Do not use alcohol to clean the unit. Lifeloc offers alcohol free cleaning wipes specific for your unit. See page 25 for more details.

Batteries

Your FC10 default setting is for four AA batteries. However, you do have the ability to use NiMH rechargeable batteries as well.

To use NiMH, insert the batteries as directed and power on the unit.

Press the **Function** button until the display reads “SETTINGS”.

Press the **Execute** button. Display shows “TIME”.

Press the **Function** button until the display shows “BATTERY TYPE”.

Press the **Execute** button to change your battery settings.

Press the **Function** button to save your settings.

Momentarily press the **Power** button to return to the testing mode.

The four batteries in your FC10 should last for about 160 hours of “on” time or up to 6000 tests. It is recommended you use high-quality alkaline batteries with your unit.

Messages Explained

Message	Explanation
<1.3L Retest or Try Manual Test➤ Breath flow ended before the subject blew 1.3 liters of breath. Instruct subject to try again or use manual test mode.
>0.6➤ BAC is unusually high and above 0.6 BAC. Subject may require medical attention.
External Interference➤ External interference has been detected. Move to a different location and try again.
Flow Error - Retry & Blow Steadily➤ Exhalation not complete or interrupted. Instruct subject to blow steadily as long as they can.
Invalid Calibration/Cal Check➤ No alcohol was detected. Repeat setup, then retest.
Log Empty➤ There are no results in the memory.
Low Battery➤ Battery voltage is too low to take a test. Replace batteries.
Pump Reset Needed➤ The pump needs to be reset. Follow onscreen instructions.
Temperature➤ When calibrating or taking a test, unit is outside of temperature limits. Calibration range = 68° - 95° F (20° - 35° C) Testing range = 32° - 130° F (0° - 55° C)
Timeout➤ User blew for > 15 seconds. Please try again, blow harder.

Lifeloc Factory Warranty

The FC10 comes with a one year limited parts and labor warranty, effective on the date of purchase by the end-user.

The Warranty covers:

- Parts and labor on covered repairs
- Software updates, as applicable
- Air freight back to the customer after the unit is repaired (U.S. only)

The Warranty does not cover:

- Freight to the Lifeloc factory
- Misuse, abuse, negligence or accidents

Extended Service Plans

Extended Service Plans are available for your FC10. These provide complete coverage for an additional year at a reasonable cost and include free factory diagnostic checks. Call Lifeloc for details or purchase online at www.lifeloc.com/technical/service.html.

Service

If your FC10 should require repairs or maintenance, Lifeloc is here for you. Just an email or phone call will put you in contact with our technical support personnel. Many minor adjustments can be made over the phone.

Repairs are completed within 5 days for up to 5 units or it's free.

Notice

The FC10 is a professional device designed to be used by trained operators in conjunction with a specified, periodic maintenance and calibration/calibration check regimen. **Use by untrained operators or without periodic calibration or calibration checks may result in invalid results or incorrect interpretation of results. FC10 is not to be used by children under 12 years of age.**

DO NOT DRINK AND DRIVE. Lifeloc strongly recommends that no vehicle or machinery be operated after alcohol consumption. Even small quantities of alcohol can result in driving impairment.

The FC10 is not waterproof and should not be immersed in or exposed to excessive water. The FC10 is not suitable for use in a potentially explosive environment. The FC10 cannot be used inside an oxygen tent.

If instrument will not be used for more than 6 months remove battery to avoid damage to the instrument caused by leaking battery acid.

Disposal of Instrument



At the end of the instrument's service life:

- Do Not dispose of the FC10 as unsorted municipal waste.
- Dispose of the FC10 in accordance with national waste disposal regulations.

Specifications

Size.....	2.6" x 5" x 1.25" (66 x 127 x 32 mm)
Weight [w/ batteries]	9 oz. (255 grams)
Measurement Range000 to .600 BAC
Accuracy	±.005 BAC up to .100 BAC ±5% for .100 - .400 BAC
Battery Life	Approximately 160 hours or up to 6000 tests

We recommend storing the FC10 in temperatures between 32° - 130° F (0° - 55° C)

Accessories & Supplies

Lifeloc offers a complete line of accessories and supplies for your FC10, including:
For the most current listing of supplies for your FC10, go to:

- www.lifeloc.com. Click on **Supplies>FC Series**
- or -
- www.lifeloc.com/store/supplies-fcseries.html

You can place your order online, via fax to 303.431.1423, or call Customer Service at 303-431-9500 or 800-722-4817.



Mouthpieces



Rubber Grip



Carrying Cases



Cleaning Wipes



Certified
Simulator
Solution



Dry Gas Standards
and Calibration Kits



Wet Bath
Simulators

User Settings Chart

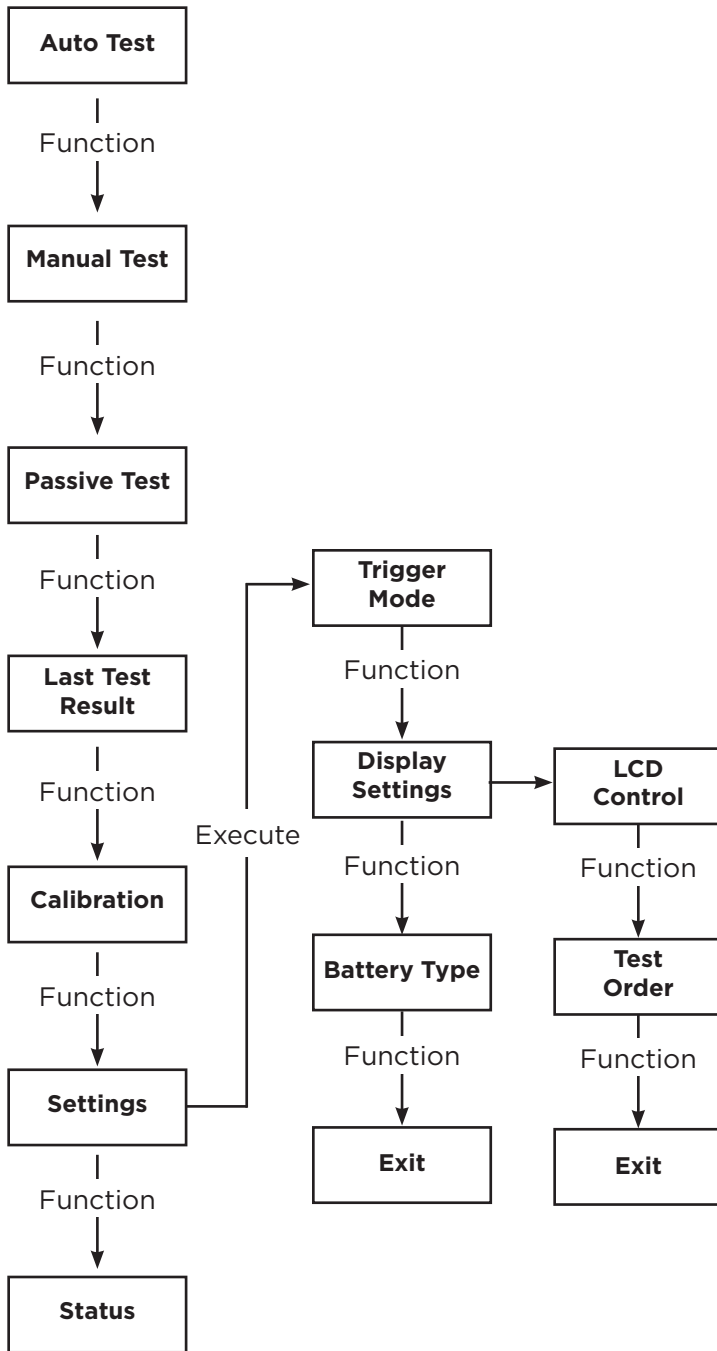

Calibration Display Chart

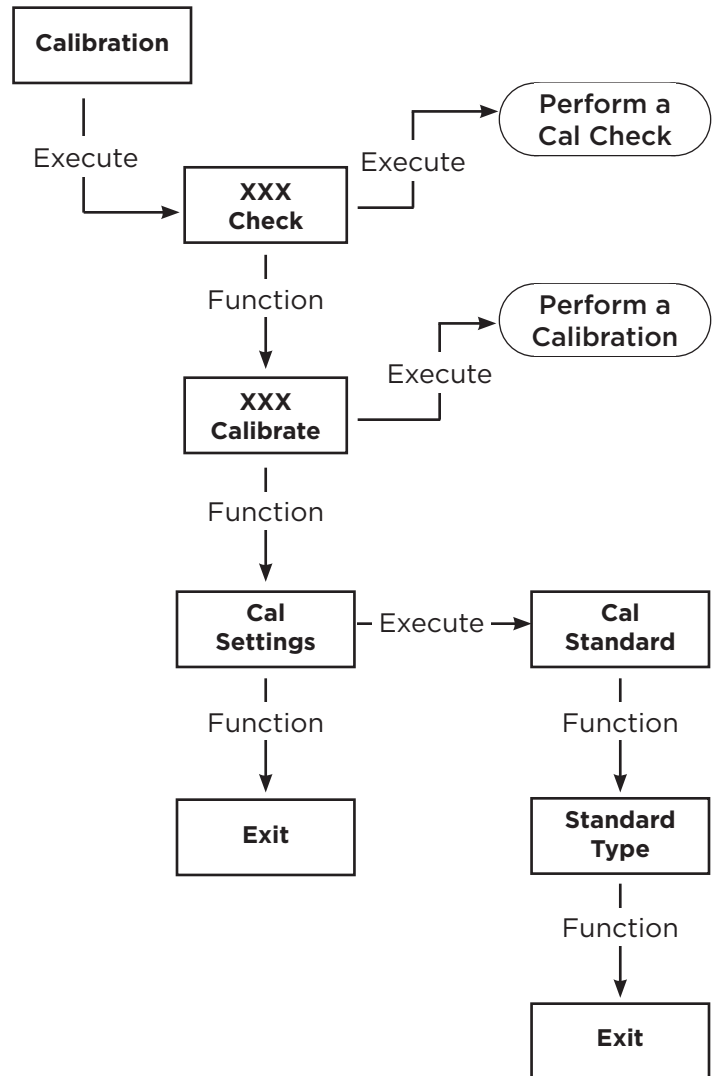



12441 West 49th Avenue, Suite 4
Wheat Ridge, CO 80033
303.431.9500 | 800.722.4872
fax: 303.431.1423
www.lifeloc.com

Hours of Operation: 7:30 am - 4:30 pm MST

If you are calling outside of these hours, please leave us a voice message. We will contact you the following business day!

From our single location in Wheat Ridge, Colorado, we manufacture and service our products with you in mind. Every product is designed with quality and ease-of-use as our priorities. And our 5 Star Service is the fastest in the industry.

Lifeloc breath testers are used across the US and in over 35 countries. We carry all of the accessories and supplies for your breath test equipment. Please call us to reorder supplies and accessories or for information on purchasing additional testers.

Lifeloc FC10

Operations Manual